









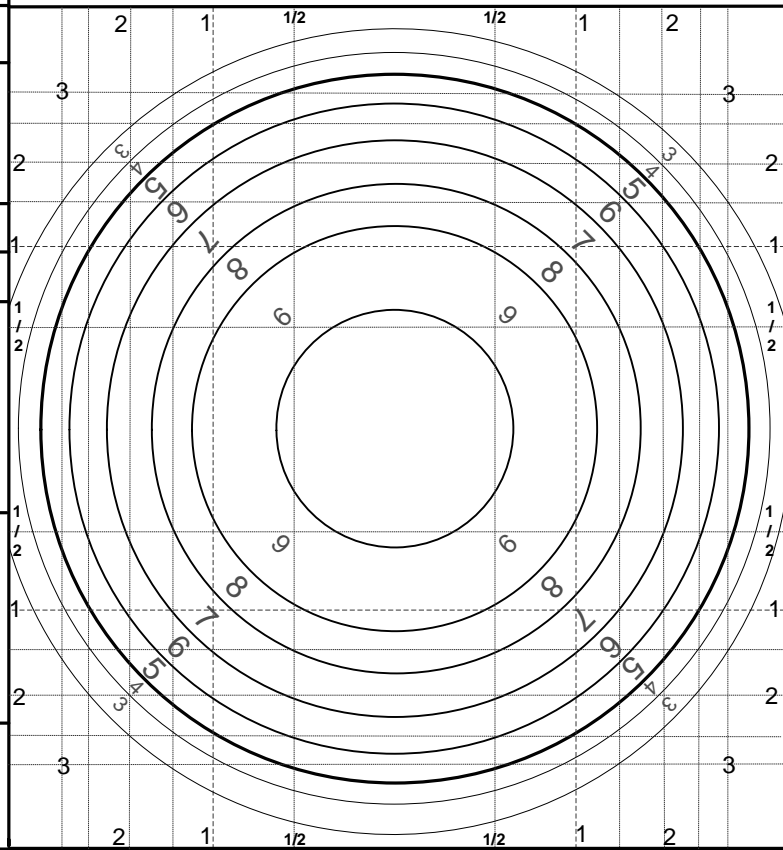

300 Meters

Place										Date									
Target No.					Relay					Time									
Rifle					Ammunition														
Light Direction Temp					Wind Direction MPH					Mirage					MM / Sights				
																			
Elevation Zero										Windage Zero									
Elevation Used										Windage Used									
0-1-T90%	SS1		SS2		1	2	3	4	5	6	7	8	9	10	TOTAL				
Elevation																			
Windage																			
Call																			
Value																			
GRP 8/04/05	SS3		SS4		11	12	13	14	15	16	17	18	19	20	TOTAL				
Elevation																			
Windage																			
Call																			
Value																			
Reloading Information										Sights					Score				
Brass					Primers					E on									
Powder					Gr. Wt.					W on									
Bullet					OAL														



300 Meters

Place										Date									
Target No.					Relay					Time									
Rifle					Ammunition														
Light Direction Temp					Wind Direction MPH					Mirage					MM / Sights				
																			
Elevation Zero										Windage Zero									
Elevation Used										Windage Used									
0-1-T90%	SS1		SS2		1	2	3	4	5	6	7	8	9	10	TOTAL				
Elevation																			
Windage																			
Call																			
Value																			
GRP 8/04/05	SS3		SS4		11	12	13	14	15	16	17	18	19	20	TOTAL				
Elevation																			
Windage																			
Call																			
Value																			
Reloading Information										Sights					Score				
Brass					Primers					E on									
Powder					Gr. Wt.					W on									
Bullet					OAL														

